

Room actuator 4/2gang 230V RMD
Order No. : 7531 40 19

Operation- and Assembly Instructions

1 Safety instructions

Electrical equipment may only be installed and fitted by electrically skilled persons.

Failure to observe the instructions may cause damage to the device and result in fire and other hazards.

Danger of electric shock. Always disconnect before carrying out work on the device or load. At the same time, take into account all circuit breakers that supply dangerous voltage to the device or load.

Danger of electric shock. Device is not suitable for disconnection from supply voltage.

Danger of electric shock on the SELV/PELV installation. Not suitable for switching SELV/PELV voltages.

Only connect electrothermal actuators to the heating outputs. Do not connect any inductive or capacitive loads. Device can be damaged.

Do not operate electrothermal valve drives with DC. Device can be damaged.

Do not connect any three-phase motors. Device can be damaged.

These instructions are an integral part of the product, and must remain with the end customer.

2 Device components

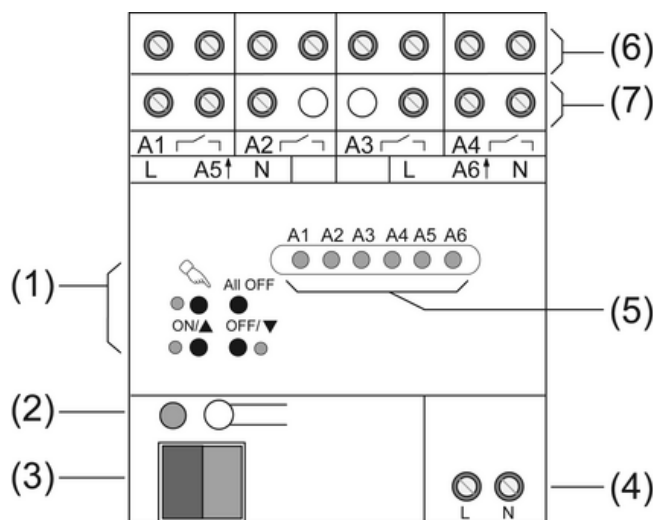

Figure 1: Device components front view

- (1) Button field for manual control
- (2) Programming button and LEDs
- (3) KNX connection
- (4) Connection for mains supply
- (5) Status LEDs for outputs
- (6) Connection of loads / hangings
- (7) Connection of actuators 230 V

3 Function

System information

This device is a product of the KNX system and complies with the KNX directives. Detailed technical knowledge obtained in KNX training courses is a prerequisite to proper understanding.

The function of this device depends upon the software. Detailed information on loadable software and attainable functionality as well as the software itself can be obtained from the manufacturer's product database.

Planning, installation and commissioning of the device are carried out with the aid of KNX-certified software. Full functionality with KNX commissioning software version ETS3.0d onwards.

An updated version of the product database, technical descriptions and conversion programs and other auxiliary programs are available on our Internet website.

Intended use

- Switching of AC 230 V electrical loads with floating contacts
- Switching of electrically-driven Venetian blinds, shutters, awnings and similar hangings
- Heating outputs: Electronic outputs for switching electrothermal actuators
- Installation in distribution boxes on DIN rail according to EN 60715

Product characteristics

- Outputs can be operated manually, construction site mode
- Feedback in manual mode and in bus mode
- Light scene function
- Disabling of individual outputs manually or via bus

Switching function

- Operation as NO or NC contacts
- Logic and restraint function
- Feedback function
- Central switching function with collective feedback
- Time functions: switch-on delay, switch-off delay, staircase lighting timer with run-on time

Blind function

- Suitable for 230 V AC motors
- Blind/shutter position directly controllable
- Slat position directly controllable
- Feedback of driving state, blind/shutter position and slat position
- Forced position through higher-level controller
- Safety function: 3 independent wind alarms, rain alarm, frost alarm
- Sun protection function

Actuator function

- Switching operation or PWM operation
- Actuators with characteristics opened or closed without power
- Overload-protected, short circuit-protected
- Emergency operation in case of bus voltage failure for summer and winter
- Protection against seized valves
- Forced position
- Cyclical monitoring of the input signals can be parameterized

i PWM operation: electrothermal actuators only have the positions Open and Closed. In PWM operation, switch-on and switch-off during the drive's cycle time achieves an almost constant behaviour.

4 Operation

Operating elements

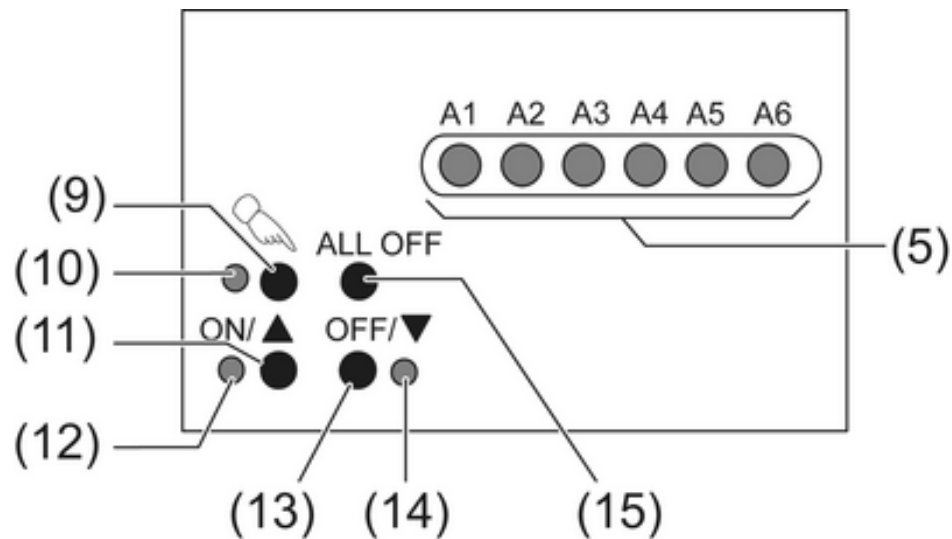

Figure 2: Operating elements – Overview

- (5) Status LEDs for outputs
- (9) Button – Manual control
- (10) LED – On: Continuous manual mode active
- (11) Button **ON/▲** – Switch on or open valve or move hanging upwards / Stop
- (12) LED **ON/▲** – ON: Switched on or hanging moves up, manual mode
- (13) Button **OFF/▼** – Switch off or close valve or move hanging downwards / Stop
- (14) LED **OFF/▼** – ON: Switched off or hanging moves down, manual mode
- (15) Button **ALL OFF** – All outputs off, close all valves and stop all drives stop

Status indication

The status LED **A1...A6** (5) indicate the states of the outputs.

- Off: Output switched off
- On: Output switched on
- Flashes slowly: Output in manual mode
- Flashes quickly: Output disabled via continuous manual mode

Heating outputs **A5** and **A6**: The LED display does not take the characteristic of the actuator into account, but refers to the state of the output instead. **ON** = with current; **OFF** = without current.

In PWM operation the state of the connected actuators and controlled valves cannot be deduced from the LED display.

Operating modes



- Bus operation: Operation via push-button sensors or other bus devices
 - Short-term manual operation: Manual operation locally with button field, automatic return to bus operation.
 - Continuous manual mode: Exclusively manual operation on the device
- No bus operation is possible in manual mode.
 - No manual mode is possible in case of bus failure.
 - After a bus failure and restoration the device switches to bus operation.
 - After a power failure and restoration the device switches to bus operation.
 - The manual mode can be disabled in ongoing operation via a bus telegram.

Priorities for blinds operation

- Highest priority: manual mode
- 2nd priority: forced position
- 3rd priority: safety function
- 4th priority: sun protection
- Lowest priority: bus mode: moving up/down, slat positioning, scenes, positioning

Switching on the temporary manual control

Operation using the button field is programmed and not disabled.

- Press  button briefly for less than 1 second.
LED **A1** flashes, LED  remains off.
-  After 5 seconds without a button-press, the actuator automatically returns to bus operation.

Deactivating temporary manual control

The device is in short-term manual mode.

- No button-press for 5 seconds.
- or -
- Press  button briefly as many time as necessary until the actuator leaves the short-time manual mode.

LEDs **A1...A6** no longer flash, but rather indicate the output status.



Switching outputs: depending on the programming, the output relays switch to the position that is active after the manual mode is switched off, e.g. to the forced position, logic function.

Blind/shutter outputs: depending on the programming, the hangings move to the position that is active after the manual mode is switched off, e.g. to the forced position, safety or sun protection position.

Heating outputs: When switching off the manual control, the outputs, depending on the programming, switch to the active position, e.g. forced position, logic operation.



Switching on permanent manual control

Operation using the button field is programmed and not disabled.

- Press the  button for at least 5 seconds.
LED  is illuminated, status LED **A1** flashes, continuous manual mode is switched on.

Deactivating permanent manual control

The device is in continuous manual mode.

- Press the  button for at least 5 seconds.
LED  is off, bus operation is switched on.

Switching outputs: depending on the programming, the output relays switch to the position that is active after the manual mode is switched off, e.g. to the forced position, logic function.

Blind/shutter outputs: depending on the programming, the hangings move to the position that is active after the manual mode is switched off, e.g. to the forced position, safety or sun protection position.

Heating outputs: When switching off the manual control, the outputs, depending on the programming, switch to the active position, e.g. forced position, logic operation.

Operating the outputs

The device is in continuous or short-term manual mode.

- Keep pressing  button briefly for less than 1 second until the desired output is selected.
The LED of the selected output **A1...A6** flashes.
The LEDs **ON/▲** and **OFF/▼** indicate the status.
- Operate output with **ON/▲** button or **OFF/▼** button.

Switching outputs: Switch on or switch off.

Venetian blind output:



Short: Stop hanging.

Long: Move hanging up/down.

Heating outputs: Open or close valve.

The selected output executes the corresponding commands.

The LEDs **ON/▲** and **OFF/▼** indicate the status.

-  Heating outputs with PWM: After switching on with **ON/▲**, the output regulates to the programmed fixed value. The LEDs only indicate the state of the output and not the state of the heating function.
-  Short-term manual operation: After running through all of the outputs the device exits manual mode after another brief press.

Disabling individual outputs

The device is in continuous manual mode.

- Press  button briefly as many times as necessary until the desired output is selected. The status LED of the selected output **A1...** flashes.
- Press **ON/▲** and **OFF/▼** buttons simultaneously for at least 5 seconds. Selected output is disabled. The status LED of the selected output **A1...** flashes quickly.
- Activate bus mode (see section Deactivating permanent manual control).

 A disabled output can be operated in permanent manual mode.

 If a disabled output is selected in manual control, the LEDs flash twice briefly with a time interval.

Re-enabling outputs

The device is in continuous manual mode.

- Press  button briefly as many times as necessary until the desired output is selected. The status LEDs of the selected output **A1...** flash twice briefly at time intervals.
- Press **ON/▲** and **OFF/▼** buttons simultaneously for at least 5 seconds. Selected output **A1...** is enabled. LED of the selected output **A1...** flashes slowly.
- Activate bus mode (see section Deactivating permanent manual control).

5 Information for electrically skilled persons

5.1 Fitting and electrical connection



DANGER!

Electrical shock when live parts are touched.

Electrical shocks can be fatal.

Before carrying out work on the device or load, disengage all the corresponding circuit breakers. Cover up live parts in the working environment.

Fitting the device

Observe the temperature range. Ensure sufficient cooling.

- Mount the device on DIN rail. Output terminals must be at the top.

Connecting the device

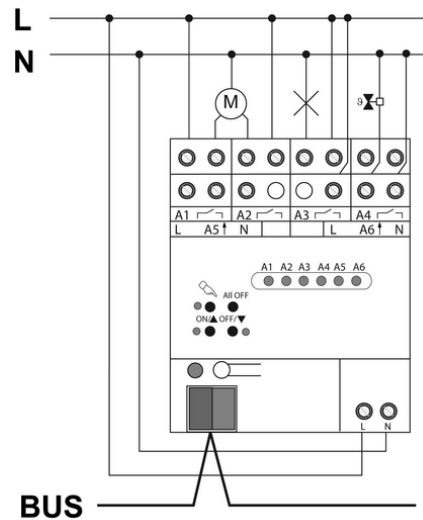

Figure 3: Connection example

- Connect bus cable with connecting terminal (Figure 3).
 - Connect mains power supply.
 - Connect loads as described in the following chapters.
 - If multiple miniature circuit breakers supply dangerous voltages to the device or load, couple the miniature circuit breakers or label them with a warning, to ensure release is guaranteed.
- i** Delivery state: Building site operation, the outputs can be operated using a keypad. All relay outputs are set as Venetian blind outputs.

Connecting switched loads

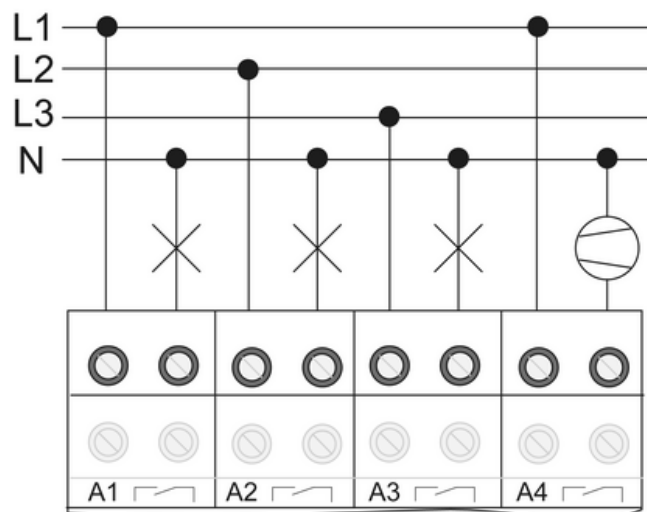

Figure 4: Connection example of switched loads

Output is parameterised as a switching output.

- Connected switched loads (Figure 4).

Connecting Venetian blind motors

Two adjacent relay outputs respectively form a Venetian blind output for Venetian blind operation. In each case the left-hand relay output **A1, A3** is intended for the up direction, and the right-hand load output **A2, A4** for the down direction.

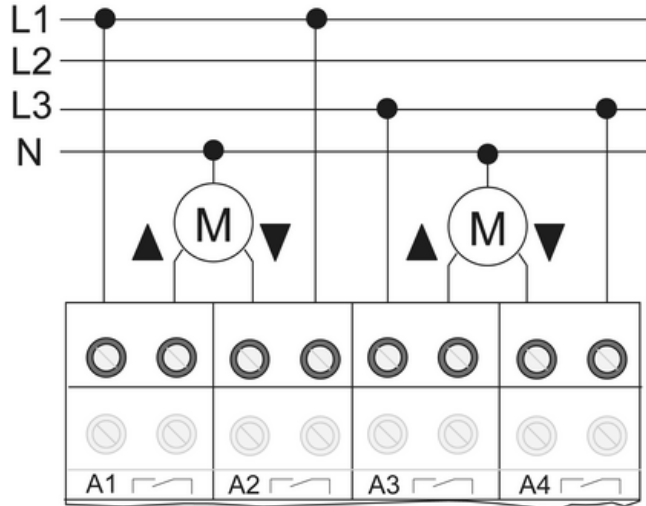

Figure 5: Connection example of Venetian blind motors

Output is parameterised as a blind/shutter output.



CAUTION!

Danger of destruction if several motors are connected in parallel to one output. Limit switch contacts can weld together and motors, blinds/shutters and the venetian blind actuator can be destroyed.

Observe the manufacturer's instructions. Use cutoff relay if necessary!

- Connecting Venetian blind motors (Figure 5).

Connect actuators 230 V

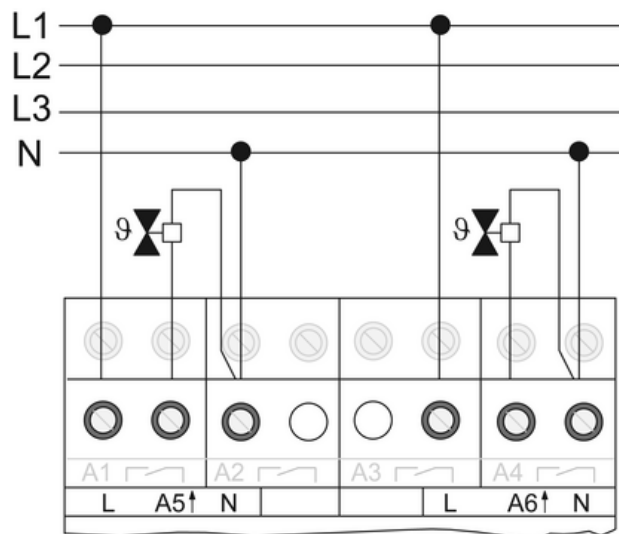

Figure 6: Connection example of electrothermal actuators 230 V

- Connect actuators (Figure 6). Use a maximum of 4 actuators per output.
- i** Connect electrothermal actuators only.
- i** In the case of thermal actuators, please pay attention to the characteristic – "opened deenergised" or "closed deenergised"– (see configuration data).

Installing the cover

It is necessary to install a cover to protect the bus connection against hazardous voltages in the connection area.



Figure 7: Installing the cover

- Route the bus line towards the rear.
- Install cover on top of the bus terminal so that it snaps into place (Figure 7).

Removing the cover

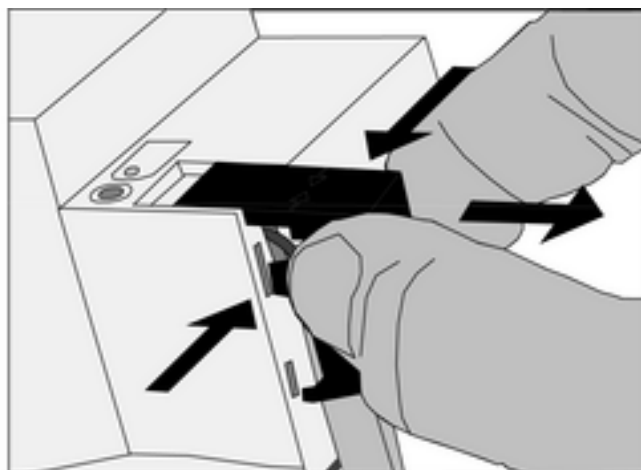

Figure 8: Removing the cover

- Press the cover to the side and pull it off (Figure 8).

5.2 Commissioning

Measuring the hanging and slat operation time

The blind/shutter travelling time is important for position and scene runs. For slatted Venetian blinds the slat adjusting time is by design part of the overall blind/shutter travelling time. The opening angle of the slats is therefore set as the operation time between the positions "Open" and "Closed".

The upwards travel generally lasts longer than the downwards travel, and is taken into account as the operation time extension in %.

- Measure upwards and downwards operation time of the hanging.
- Measure slat adjusting time between "Open" and "Closed".
- Enter the measured values in the parameter setting – Downwards travel in seconds and operation time extension in percent.

Load the address and the application software

- Switch on the bus voltage
- Assign physical address.
- Load the application software into the device.
- Note the physical address on the device label.

6 Appendix

6.1 Technical data

Supply	
Rated voltage	AC 230 / 240 V ~
Mains frequency	50 / 60 Hz
Power loss	max. 6 W
Ambient conditions	
Ambient temperature	-5 ... +45 °C
Storage/transport temperature	-25 ... +70 °C
Heating outputs	
Output type	Semi-conductor (Triac), ε
Switching voltage	AC 250 V ~
Switching current	max. 50 mA
Switch-on current	max. 1.5 A (2 sec)
Number of drives per output	max. 4
Relay outputs	
Contact type	μ contact, potential-free NO contact
Switching voltage	AC 250 V ~
Switching current AC1	16 A
Switching current AC3	6 A
Fluorescent lamps	16 AX
Switch-on current 200 μs	max. 800 U
Switch-on current 20 ms	max. 165 U
Connected load of relay outputs	
Ohmic load	3000 W
Blind, fan motors	1380 VA
Lamp loads	
Incandescent lamps	3000 W
HV halogen lamps	2500 W
Tronic transformers	1500 W
Inductive transformers	1200 VA
Fluorescent lamps T5/T8 uncompensated	1000 W
parallel compensated	1160 W (140 μF)
Duo circuit	2300 W (140 μF)
Compact fluorescent lamps	

uncompensated	1000 W
parallel compensated	1160 W (140 µF)
Mercury vapour lamps	
uncompensated	1000 W
parallel compensated	1160 W (140 µF)
Connections supply and load	
Connection mode	Screw terminal
single stranded	0.5 ... 4 mm ²
finely stranded without conductor sleeve	0.5 ... 4 mm ²
finely stranded with conductor sleeve	0.5 ... 2.5 mm ²
Fitting width	72 mm / 4 modules
Weight	approx. 290 g
KNX	
KNX medium	TP 1
Commissioning mode	S-mode
Rated voltage KNX	DC 21 ... 32 V SELV
Power consumption KNX	typical 150 mW
Connection type for bus	Connection terminal

6.2 Troubleshooting

Manual control with button field not possible

Cause 1: Manual control has not been programmed.

Program manual control.

Cause 2: Manual control via bus disabled.

Enable manual control.

Cause 3: No mains voltage.

Switch on mains voltage. Check fuse

Output cannot be operated.

Cause: Output is disabled.

Cancel disabling.

None of the outputs can be operated.

Cause 1: All of the outputs are disabled-

Cancel disabling.

Cause 2: Continuous manual mode is active.

Deactivate manual mode (see chapter "Switch off continuous manual mode").

Cause 3: Application software has been stopped, programming LED is flashing.

Perform reset: Disconnect device from bus, switch on again after 5 seconds.

Operation via bus is not possible

Cause 1: No bus voltage.

Switch on bus voltage, have installation checked by electrician.

Cause 2: Application software has been stopped, programming LED is flashing.

Perform reset: Disconnect device from bus, switch on again after 5 seconds.

Cause 3: No application software or faulty application software loaded.

Check programming and correct.

6.3 Warranty

We reserve the right to make technical and formal changes to the product in the interest of technical progress.

Our products are under guarantee within the scope of the statutory provisions.

If you have a warranty claim, please contact the point of sale or ship the device postage free with a description of the fault to the appropriate regional representative.

Berker GmbH & Co. KG
Klagebach 38
58579 Schalksmühle/Germany
Telefon + 49 (0) 2355/905-0
Telefax + 49 (0) 2355/905-111
www.berker.de